

Introduction

The requirements relating to driving safety, driving comfort, exhaust emissions and fuel economy are becoming ever more stringent.

This entails more intensive information exchange between control units.

A well-engineered solution is necessary to ensure that the electrics/electronics in the vehicle still remain manageable and do not take up too much space.

The **CAN data bus** by Bosch is such a solution. It was developed specially for automobiles and is used by both Volkswagen and Audi.

CAN stands for Controller Area Network and means that control units are networked and interchange data.

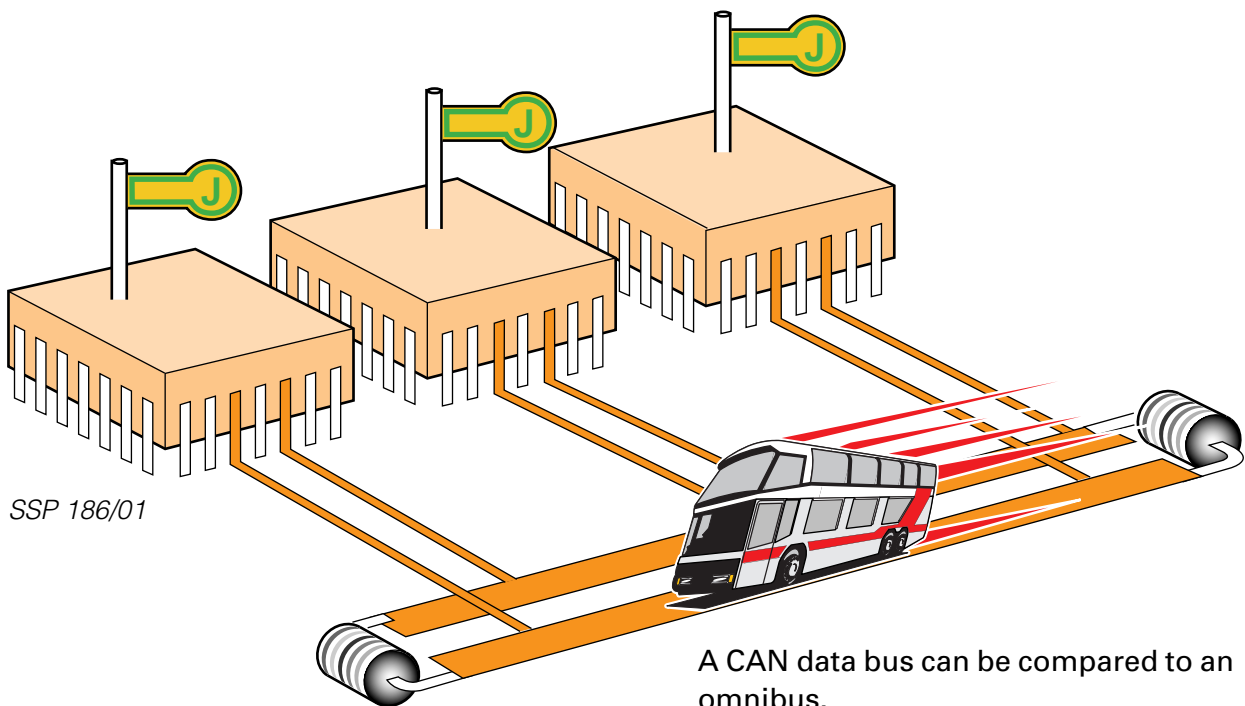







A CAN data bus can be compared to an omnibus.

Whilst the omnibus transports a large number of persons, the CAN data bus transports a large volume of information.

In this Self-study Programme we will explain to you the design and function of the **CAN data bus**.

The contents at a glance

	Page
 Introduction _____	2
 CAN data bus _____	4
 Data transfer _____	10
 Function _____	12
 CAN data bus in the convenience system _____	17
 CAN data bus in the drive train _____	24
 Test your knowledge _____	30

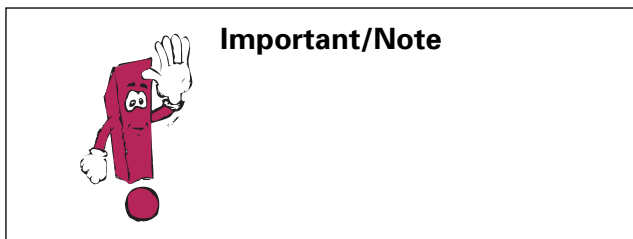

The Self-study Programme is not a Workshop Manual!

Precise instructions for testing, adjustment and repair can be found in the appropriate Workshop Manual.

CAN data bus

Data transfer

What are the possible options for data transfer in vehicles at present?

- **Option No. 1:**
Each item of information is exchanged over a separate wire.
- **Option No. 2:**
All information is exchanged between control units along a maximum of two wires: the CAN data bus.

The figure below shows you option No. 1, where each item of information is transferred along a separate wire.

A total of five wires are required for data transfer in this case.

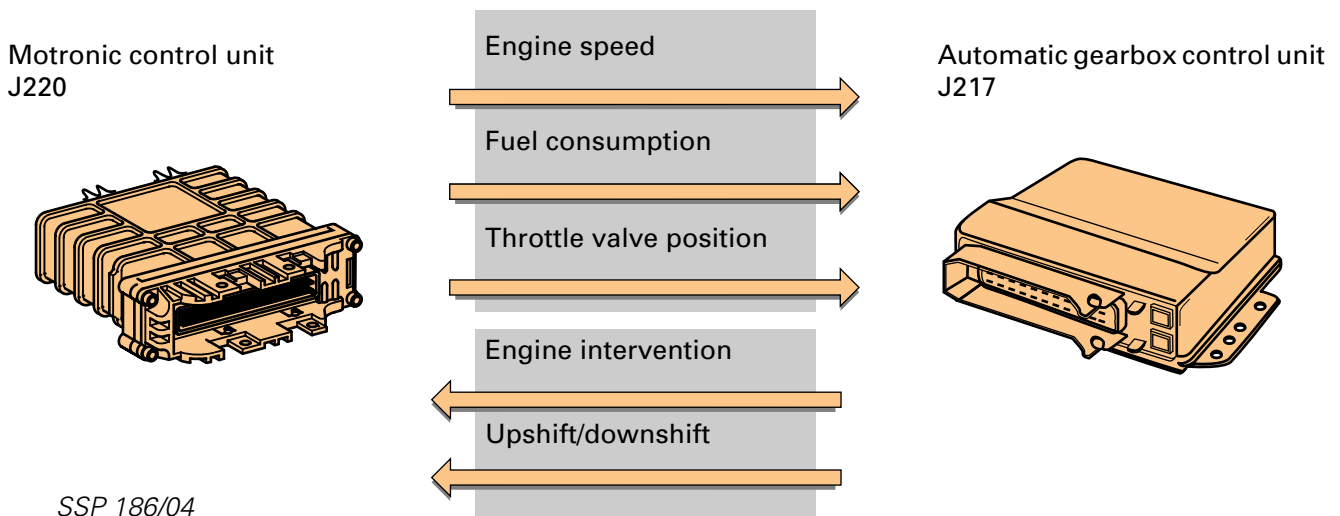

Conclusion:

A separate wire is required for each item of information.

As the volume of additional information increases, so does the number of wires and the number of pins on the control units.

Therefore, this data transfer mode is only suitable for exchanging a limited volume of information.

In contrast to option No. 1, all information is transferred along two wires in the CAN data bus.

The same data is transferred along the two bidirectional wires of the CAN data bus.

You will find further information in this Self-study Programme.

Motronic control unit
J220

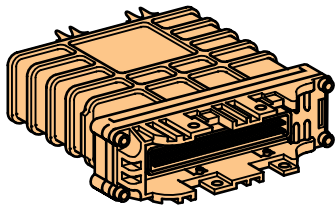

SSP 186/05

Engine speed
Fuel consumption
Throttle valve position
Engine intervention
Upshift/downshift



Automatic gearbox control unit
J217

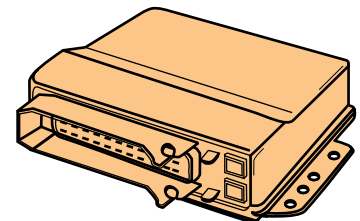

Conclusion:

With this data transfer mode, all information is transferred along two wires regardless of the number of participating control units and the volume of information involved.

Data transfer with the CAN data bus would therefore make sense if a large volume of information is exchanged between control units.

CAN data bus

The CAN data bus

is a type of data transfer between control units. It links the individual control units to form an integrated system.

The more information a control unit has regarding the state of the overall system, the better it can co-ordinate the individual functions.

The following components in the drive train form an integrated system:

- the engine control unit,
- the automatic gearbox control unit and
- the ABS control unit

The following components in the convenience system form an integrated system:

- the central control unit and
- the door control units

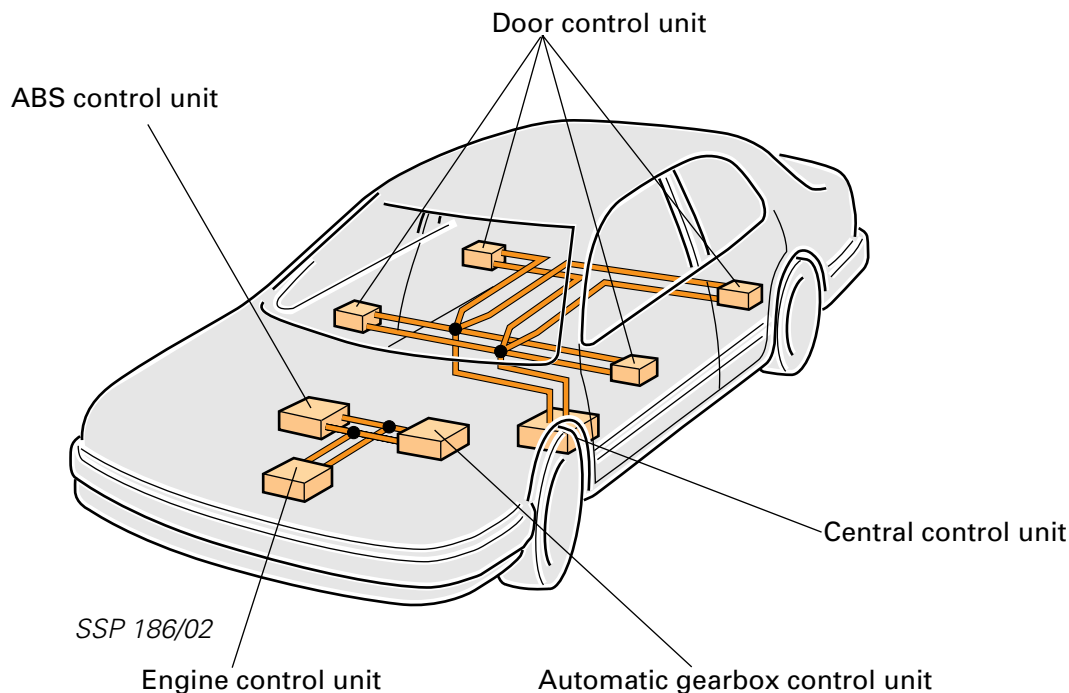

Benefits of the data bus:

- If the data protocol is extended to include additional information, only software modifications are necessary.
- Low error rate through continuous verification of the transmitted information by the control units as well as additional safeguards in the data protocols.
- Fewer sensors and signal lines through the multiple use of a sensor signal.
- High-speed data transfer is possible between control units.
- More space available through smaller control units and smaller control unit plugs.
- The CAN data bus conforms to international standards and therefore facilitates data interchange between different makes of control unit.

The principle of data transfer

Data transfer with the CAN data bus functions in much the same way as a telephone conference.

A subscriber (control unit) "speaks" data into the line network while the other subscribers "listen in" to this data.

Some subscribers will be interested in this data and will utilise it.
The other subscribers will choose to ignore this data.

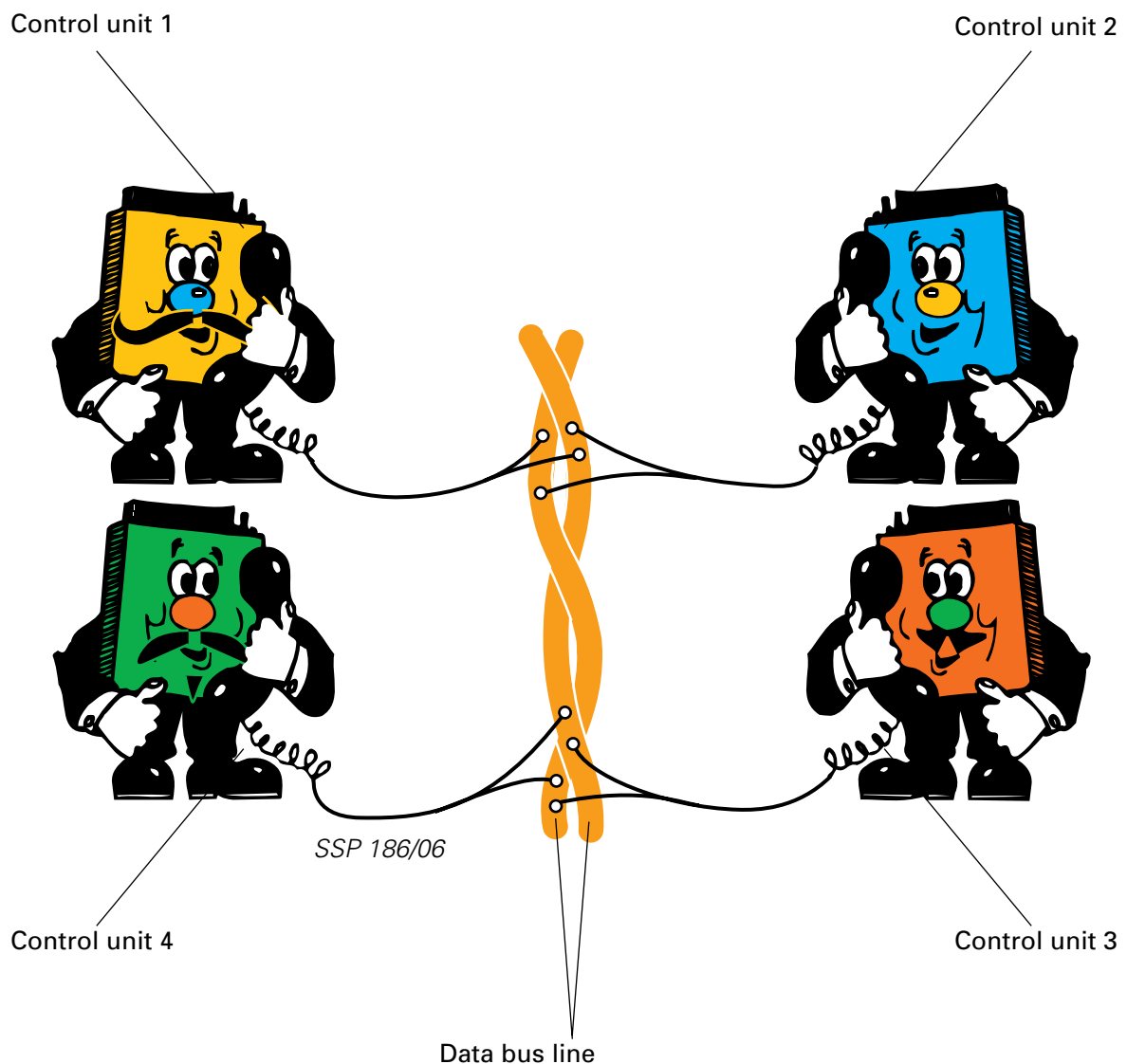

CAN data bus

What components make up a CAN data bus?

The CAN data bus comprises a controller, a transceiver, two data bus terminals and two data bus lines.

Apart from the data bus lines, the components are located in the control units. The functions of the control units are the same as before.

They have the following tasks:

The CAN controller

receives the transfer data from the microcomputer integrated in the control unit. The CAN controller processes this data and relays it to the CAN transceiver. Likewise, the CAN controller receives data from the CAN transceiver, processes it and relays it to the microcomputer integrated in the control unit.

The CAN transceiver

is a transmitter and receiver in one. It converts the data which the CAN controller supplies into electrical signals and sends this data over the data bus lines. Likewise, it receives data and converts this data for the CAN controller.

The data bus terminal

is a resistor. It prevents data sent from being reflected at the ends and returning as an echo. This would corrupt the data.

The data bus lines

are bidirectional and transfer the data. They are referred to as CAN High and CAN Low.

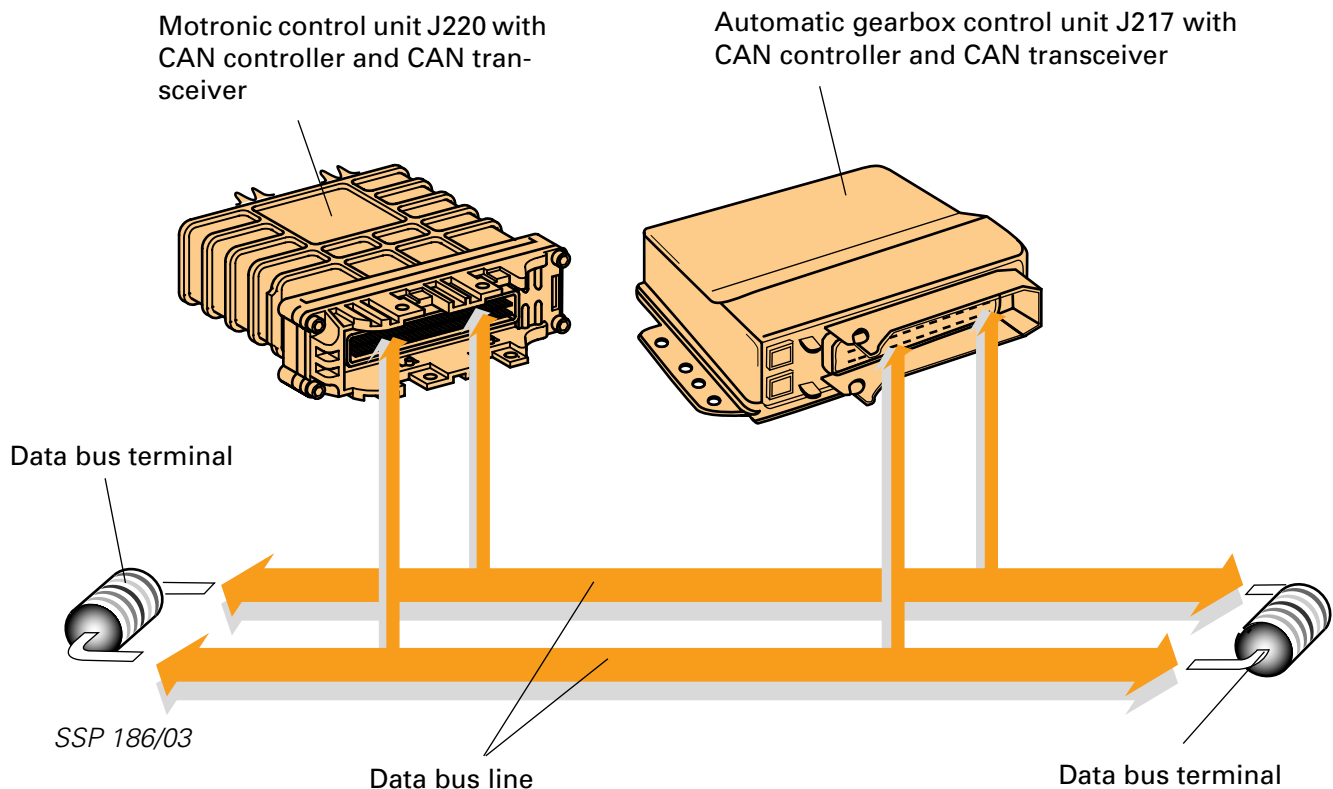

The data bus does not have a designated receiver. Data is sent over the data bus and is generally received and evaluated by all subscribers.

Data transfer process:

Supplying the data

The control unit provides data to the CAN controller for transfer.

Sending data

The CAN transceiver receives data from the CAN controller, converts it into electrical signals and sends them.

Receiving data

All other control units networked with the CAN data bus become receivers.

Checking data

The control units check whether they require the data they have received for their functions or not.

Accepting data

If the received data is important, it is accepted and processed. If not, it is ignored.

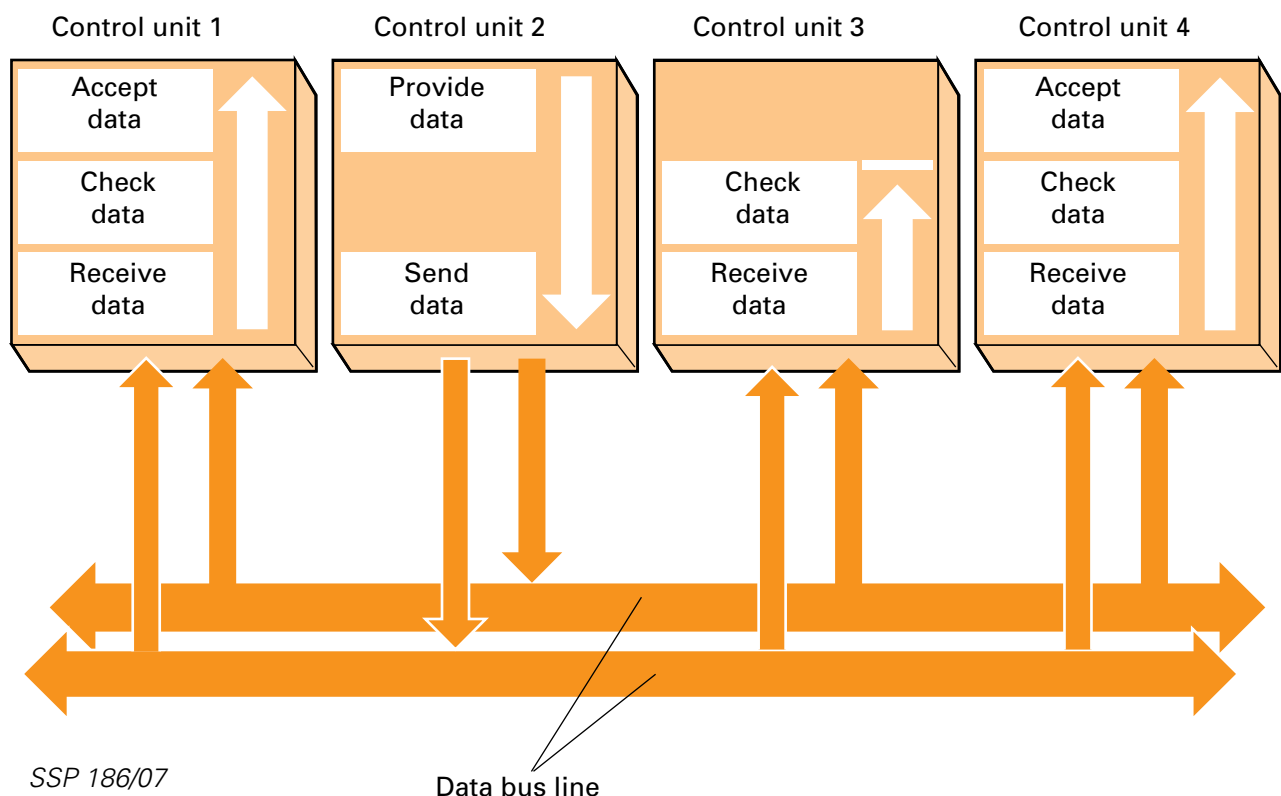

Data transfer

What does the CAN data bus transfer?

It transfers a data protocol between the control units at short intervals.

It is subdivided into seven areas.

The data protocol:

comprises a long string of bits. The number of bits in a data protocol depends on the size of the data field.



A bit is the smallest unit of information (one circuit state per unit of time). In electronics, this information can only have the value "0" or "1", i.e. "yes" or "no".

The diagram below shows the format of a data protocol. This format is identical on both data bus lines.

For simplicity's sake, only one data bus line will be shown in this Self-study Programme.

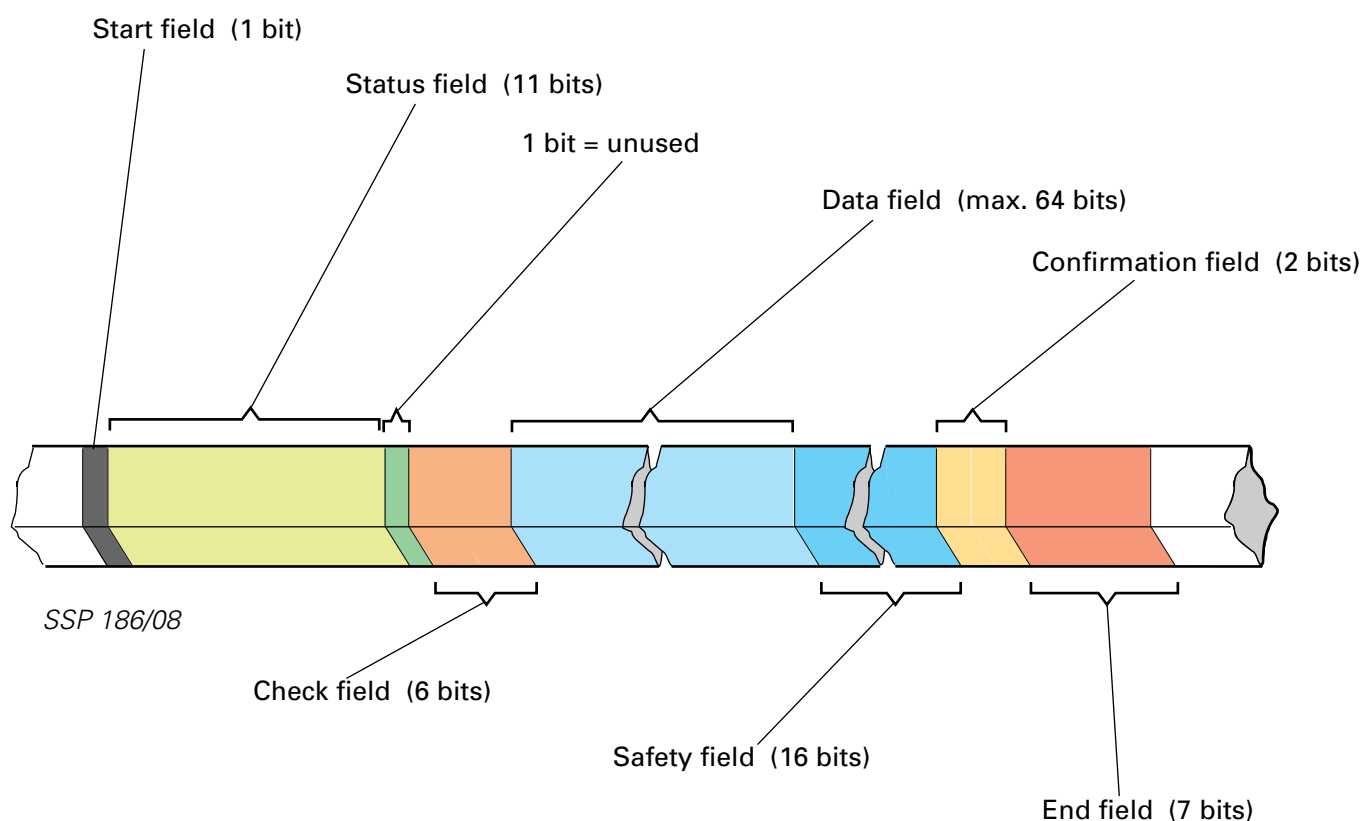

The seven areas:

The **start field**

marks the start of the data protocol. A bit with approx. 5 Volts (depending on system) is sent over the CAN High Line and a bit with approx. 0 Volts is sent over the CAN Low Line.

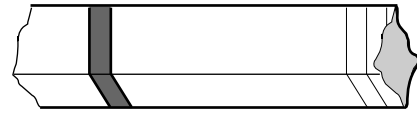

SSP 186/09

The **status field**

defines the level of priority of the data protocol. If, for instance, two control units want to send their data protocol simultaneously, the control unit with the higher priority takes precedence.

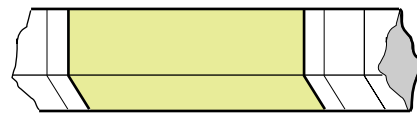

SSP 186/10

The **check field**

displays the number of items of information contained in the data field. This field allows any receiver to check whether it has received all the information transferred to it.

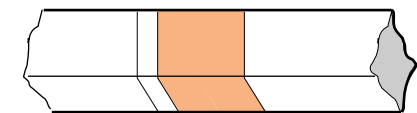

SSP 186/11

In the **data field**,

information is transferred to the other control units.

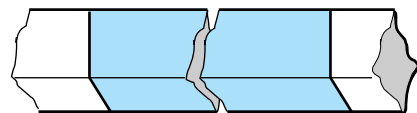

SSP 186/12

The **safety field**

detects transfer faults.

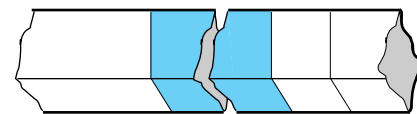

SSP 186/13

In the **confirmation field**,

the receivers signal to the transmitter that they have correctly received the data protocol. If an error is detected, the receivers notify the transmitter of this immediately. The transmitter then sends the data protocol again.

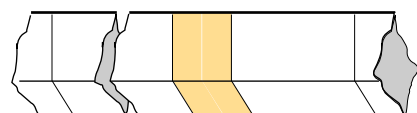

SSP 186/14

The **end field**

marks the end of the data protocol. This is the last possibility to indicate errors which lead to a repeat transfer.

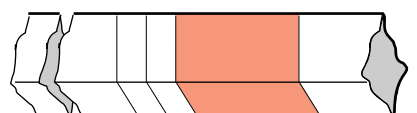

SSP 186/15

Function

How is a data protocol produced?

The data protocol comprises a string of several bits. Each bit can only have status or value "0" or "1".

Here is a simple example to explain how a status with the value "0" or "1" is generated:

The light switch

switches a light on or off. This means that the light switch can have two different states.

Status of the light switch with the value "1"

- Switch closed
- Lamp on

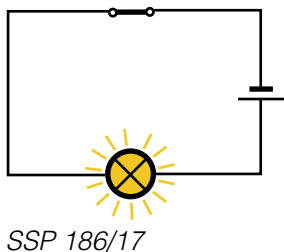

Status of the light switch with the value "0"

- Switch opened
- Lamp is not on

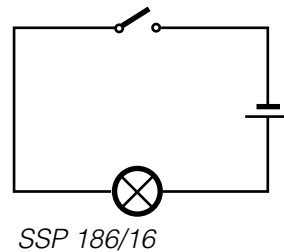

In principle, the CAN data bus functions in exactly the same way.

The transceiver

can also generate two different bit states.

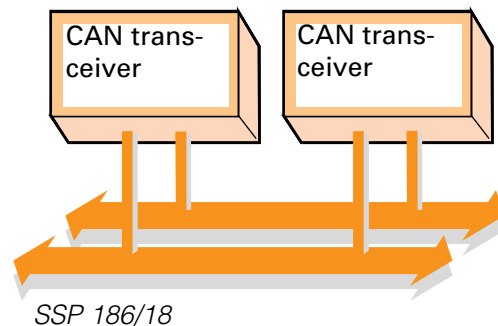

Status of bit with the value "1"

- Transceiver open, switches to 5 Volts in the convenience system (drive train: approx. 2.5 Volts)
- Voltage applied to data bus line: approx. **5 Volts** in the convenience system (drive train: approx. 2.5 Volts)

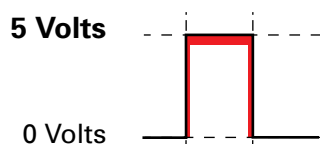

Status of the bit with the value "0"

- Transceiver closed, switches to earth
- Voltage applied to data bus line: approx. **0 Volts**

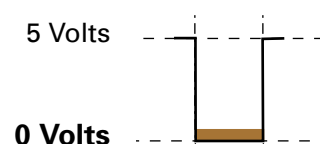



The table below shows you how information can be transferred with two consecutive bits.

With two bits, there are four possible variations.

One item of information can be assigned to each variation and is binding for all control units.

Explanatory notes:

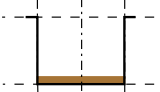
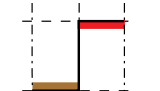
If bits 1 and 2 are transmitted with 0 Volts, the information in the table "Electric windows now in motion" or "Coolant temperature is 10°C".

Possible variation	2nd bit	1st bit	Graphic	Electric window status information	Information on coolant temperature
One	0 Volts	0 Volts		in motion	10°C
Two	0 Volts	5 Volts		not moving	20°C
Three	5 Volts	0 Volts		within range	30°C
Four	5 Volts	5 Volts		upper stop recognition	40°C

The table below shows you how the number of items of information increases with each additional bit.

Bit variants containing 1 bit	Possible information	Bit variants containing 2 bits	Possible information	Bit variants containing 3 bits	Possible information
0 Volts	10°C	0 Volts, 0 Volts	10°C	0 Volts, 0 Volts, 0 Volts	10°C
5 Volts	20°C	0 Volts, 5 Volts	20°C	0 Volts, 0 Volts, 5 Volts	20°C
		5 Volts, 0 Volts	30°C	0 Volts, 5 Volts, 0 Volts	30°C
		5 Volts, 5 Volts	40°C	0 Volts, 5 Volts, 5 Volts	40°C
				5 Volts, 0 Volts, 0 Volts	50°C
				5 Volts, 0 Volts, 5 Volts	60°C
				5 Volts, 5 Volts, 0 Volts	70°C
				5 Volts, 5 Volts, 5 Volts	80°C

The higher the number of bits, the more items of information can be transferred.
The number of possible items of information doubles with each additional bit.

Function

CAN data bus allocation

If more than one control unit wants to send its data protocol simultaneously, the system must decide which control unit comes first.

The data protocol with the highest priority is sent first.

For safety reasons, the data protocol supplied by the ABS/EDL control unit for safety reasons is more important than the data protocol supplied by the automatic gearbox control unit (driving comfort).

How are allocations made?

Each bit has a value, and this value is assigned a weighting. There are two possibilities: high weighting or low weighting.

Bit with	Value	Weighting
0 Volts	0	high weighting
5 Volts	1	low weighting

How is the priority of a data protocol recognised?

A code comprising eleven bits is assigned to each data protocol depending on its priority in the status field.

The priorities of three different data protocols are shown in the table below.

Priority	Data protocol	Status field
1	Brake I	001 1010 0000
2	Engine I	010 1000 0000
3	Gearbox I	100 0100 0000

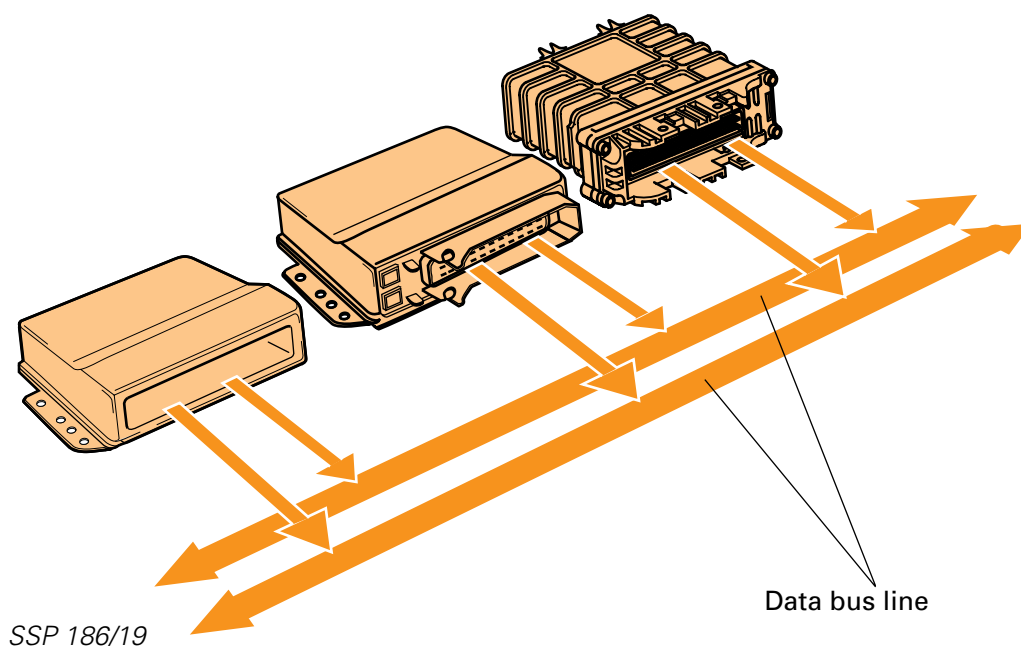

All three control units start sending their data protocol simultaneously. At the same time, they compare the data bit by bit on the data bus line.

If a control unit sends a low weighting bit and detects a high weighting bit, the control unit stops sending and becomes a receiver.

Example:

Bit 1:

- ABS/EDL control unit transmits a high weighting bit.
- Motronic control unit also transmits a high weighting bit.
- Automatic gearbox control unit transmits a low weighting bit and detects a high weighting bit on the data bus line. Thus, it loses its priority status and becomes a receiver.

Bit 2:

- ABS/EDL control unit sends a high weighting bit.
- Motronic control unit transmits a low order bit and detects a higher weighting bit on the data bus line. Thus, it loses its priority status and becomes a receiver.

Bit 3:

- ABS/EDL control unit has the highest priority and thus receives the allocation. It continues to send its data protocol until it ends.

After the ABS/EDL control unit has finished sending its data protocol, the other control units try again to transmit their data protocol.

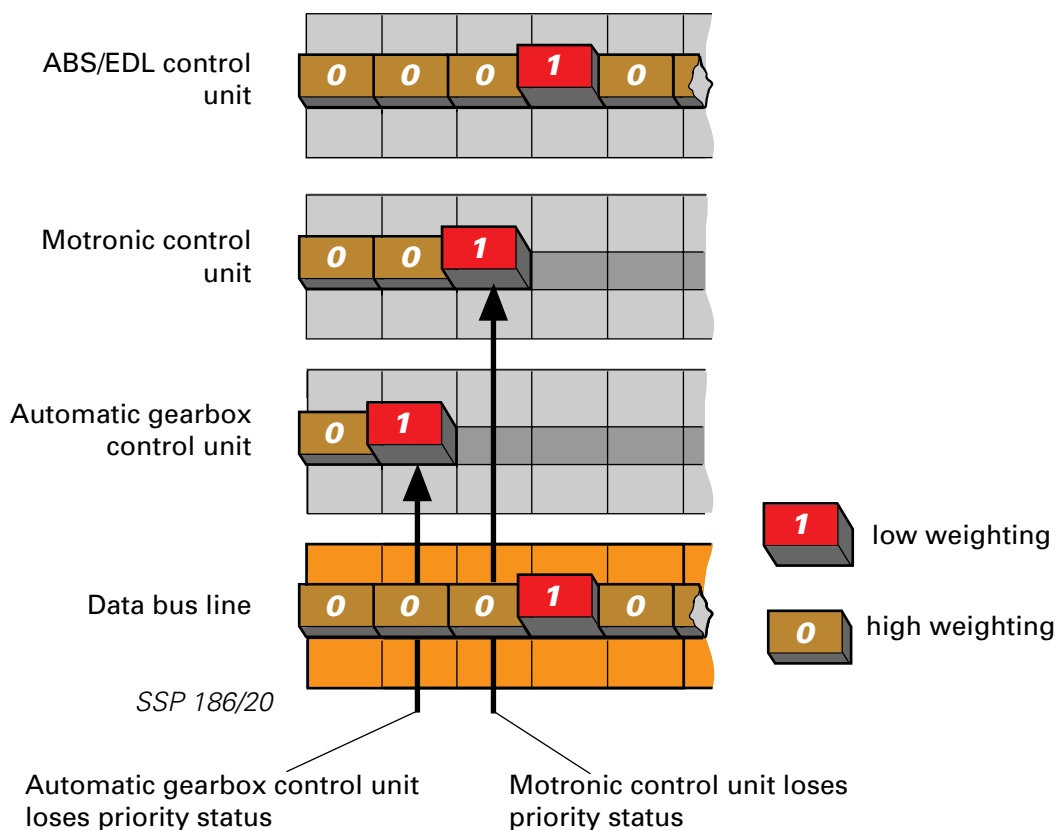

Function

Sources of interference

Sources of interference in the vehicle are components which produce sparks or in which electric circuits are open or closed during operation.

Other sources of interference include mobile telephones and transmitter stations, i.e. any object which produces electromagnetic waves. Electromagnetic waves can affect or corrupt data transfer.

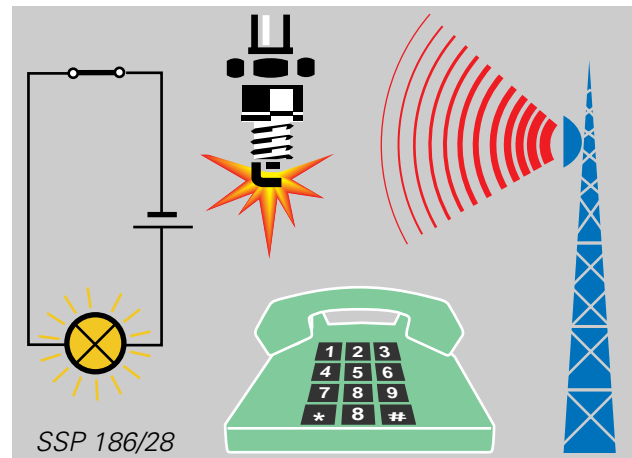

To prevent interference with the data transfer, the **two** data bus lines are twisted together. This also prevents noise emission from the data bus line.

The voltage on both lines is opposed.

That means:

If a voltage of approx. 0 Volts is applied to the one data bus line, then a voltage of approx. 5 Volts is applied to the other line and vice versa.

As a result, the total voltage remains constant at all times and the electromagnetic field effects of the two data bus lines cancel each other out.

The data bus line is protected against received radiation and is virtually neutral in sending radiation.

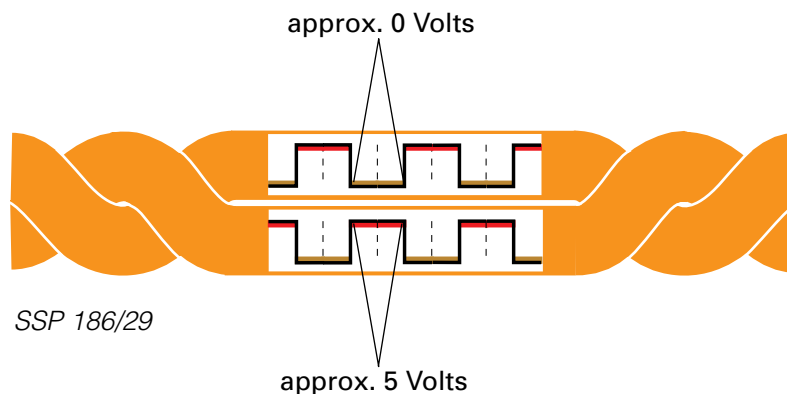

CAN data bus in convenience system

The CAN data bus in the convenience system

In the convenience system, the CAN data bus currently connects the control units of the convenience system.

These are

- a central control unit and
- two or four door control units.

The structure of the CAN data bus in the convenience system

The lines of the control units converge at one point in a star pattern. The advantage: if one of the control units fails, the other control units are still able to send their data protocols.

The following functions of the convenience system transfer data:

- Central locking
- Electric windows
- Switch illumination
- Electrically adjustable and heated door mirrors
- Self-diagnosis

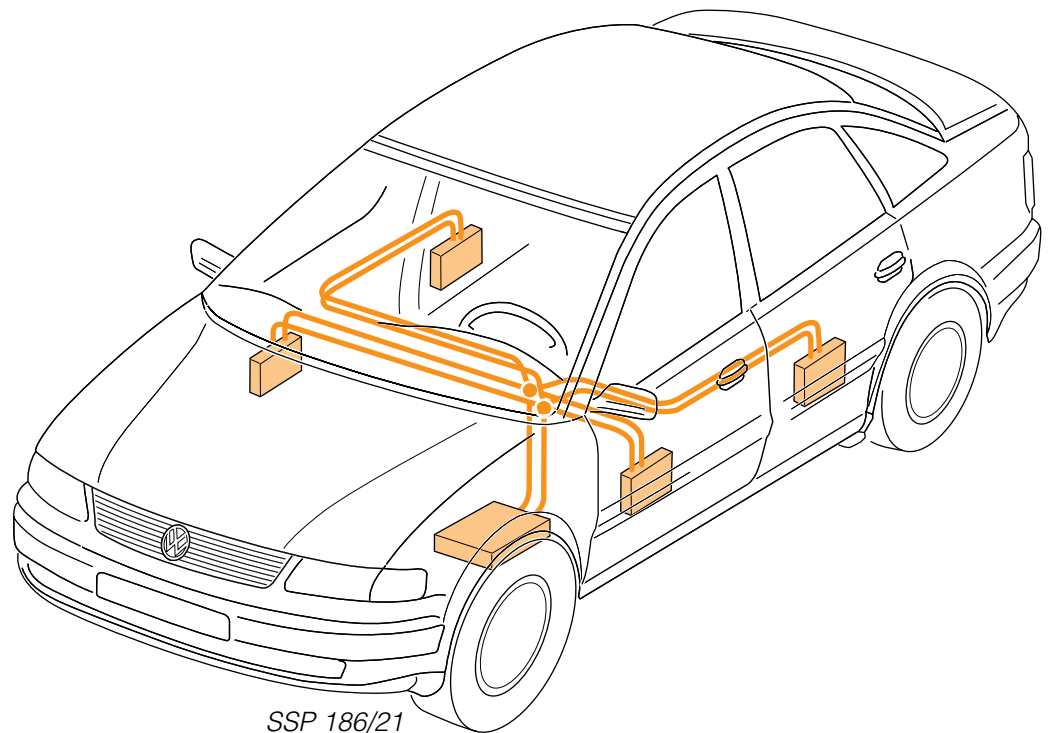

What are the advantages of the CAN data bus in the convenience system?

- Fewer lines are routed via the door connections.
- In the event of a short circuit to earth, to positive or between lines, the CAN data bus goes to emergency running mode and changes over to single-wire mode.
- Fewer diagnosis lines are required, because self-diagnosis is handled entirely by the central control unit.

CAN data bus in the convenience system

The features of the CAN data bus in the convenience system

- The data bus comprises two lines along which information is sent.
- To avoid electromagnetic interference and radiation emission, the two data bus lines are twisted together. Note twist length.
- The data bus operates at a speed of 62.5 kbit/s (62500 bits per second). This means that it lies in a speed range (low speed) from 0 - 125 kbit/s. A data protocol transfer takes approx. 1 millisecond.
- Each control unit tries to send its data at intervals of 20 milliseconds.
- Order of priority:
 1. Central control unit →
 2. Control unit on driver's side →
 3. Control unit on front passenger's side →
 4. Control unit on rear left →
 5. Control unit on rear right



SSP 186/22



SSP 186/24

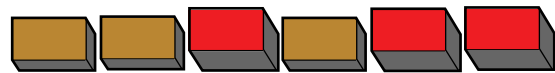

SSP 186/23

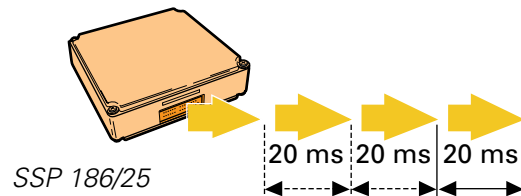

SSP 186/25

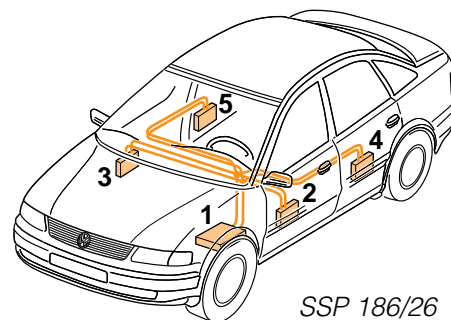

SSP 186/26

Since the data in the comfort system can be transferred at a relatively low speed, it is possible to use a transceiver with a lower power output.

The advantage is that it is possible to change over to single-wire mode if a data bus line fails. The data can still be transferred.

Information in the convenience system

The information relates to states of the individual functions.

For example, information about which radio-wave remote control was operated, current status of central locking, do errors exist, and so on.

The table shows you part of the data field of the driver's door control unit by way of an example.

You can see how and what information regarding the status of the central locking and the electric windows is transferred.

Function status	Information	Bit order					Value of bits
		Bit 5	Bit 4	Bit 3	Bit 2	Bit 1	
Central locking	Basic status			0 Volts, 0 Volts, 0 Volts			000
	Safe			0 Volts, 0 Volts, 5 Volts			001
	Locked			0 Volts, 5 Volts, 0 Volts			010
	Door unlocked			0 Volts, 5 Volts, 5 Volts			011
	Door locked			5 Volts, 0 Volts, 0 Volts			100
	Unlocked			5 Volts, 0 Volts, 5 Volts			101
	Signal error, input sensors			5 Volts, 5 Volts, 0 Volts			110
	Status error			5 Volts, 5 Volts, 5 Volts			111
Electric windows	In motion	0 Volts, 0 Volts					00
	Not moving	0 Volts, 5 Volts					01
	Within range	5 Volts, 0 Volts					10
	Upper stop recognised	5 Volts, 5 Volts					11

Example showing a possible bit order

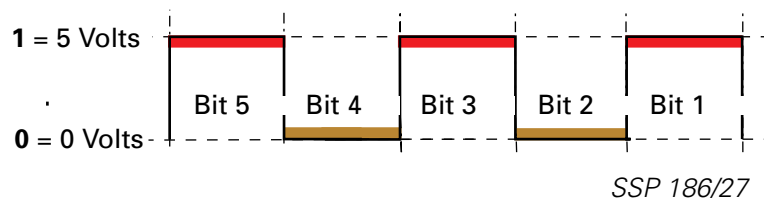

Bit order	Value	Voltage applied to data bus line	Meaning of information
3 to 1	101	5 Volts, 0 Volts, 5 Volts	The central locking is unlocked
5 to 4	01	5 Volts, 0 Volts	The window is located in the zone between the upper stop (completely closed) and 4 mm below the window seal

CAN data bus of convenience system

Networking of control units in the convenience system

Control units:

- J386 Door control unit, driver's side
- J387 Door control unit, front passenger's side
- J388 Door control unit, rear left
- J389 Door control unit, rear right
- J393 Central control unit for convenience system

Fuses:

- S6 Fuse, terminal 15 - central control unit
- S14 Fuse, terminal 30 - central control unit
- S37 Fuse, terminal 30 - electric windows
- S238 Fuse, terminal 30 - central locking

Colour coding:

- Input signal
- Output signal
- Positive
- Earth
- Data bus line High/Low

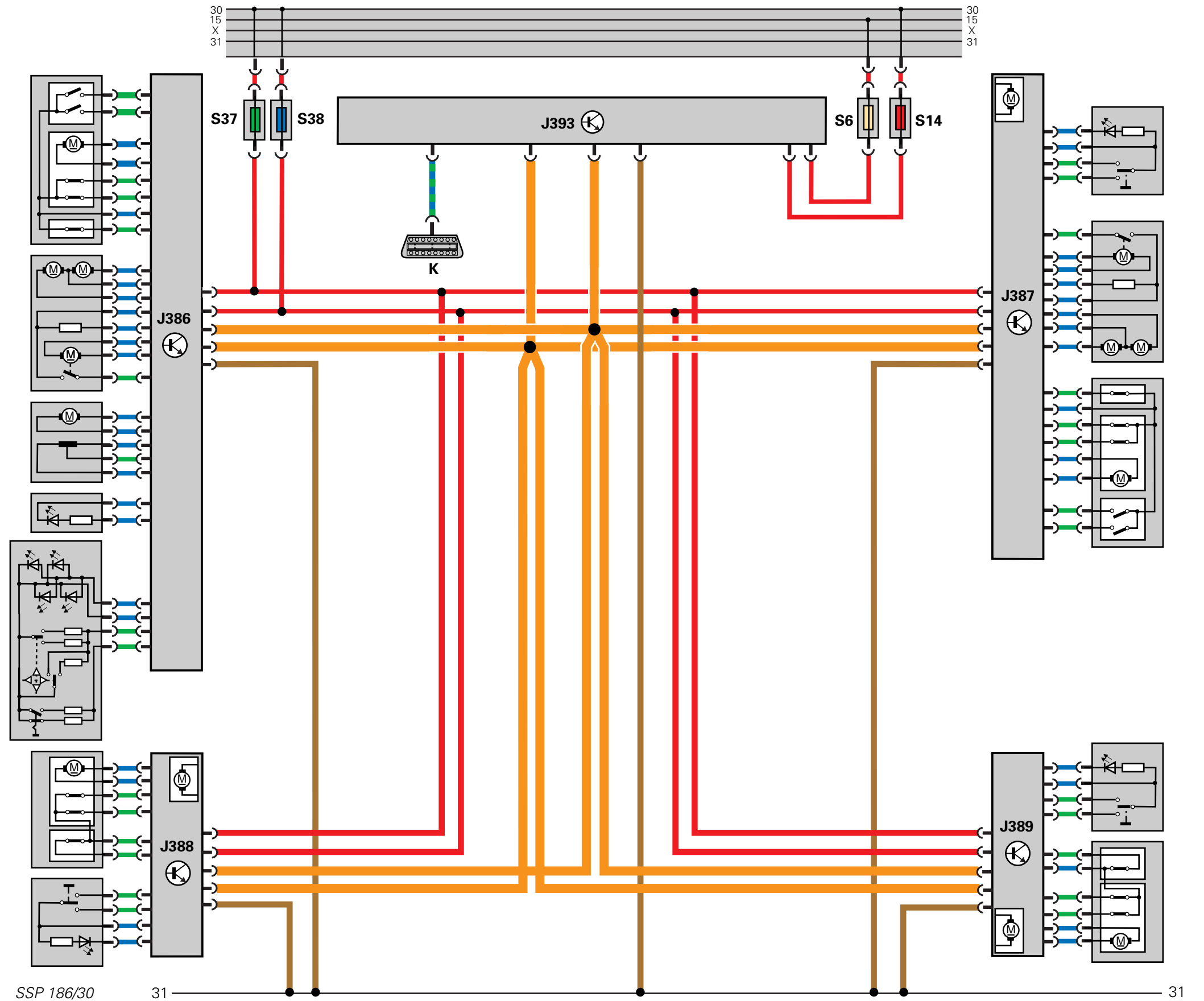

CAN data bus of convenience system

The self-diagnosis of the CAN data bus in the convenience system

Self-diagnosis can be performed with V.A.G 1551/52 or with VAS 5051 under the following address word:

46 "Convenience system"



During self-diagnosis and troubleshooting, all control units which interchange information with the CAN data bus must be regarded as an integrated system.

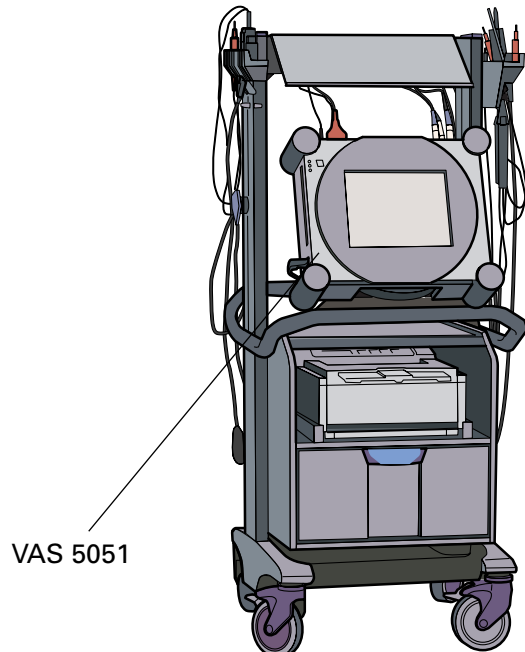

VAS 5051

SSP 186/42

The following functions are relevant to the CAN data bus:

Function 02 - Interrogate fault memory

In the fault memory, two faults are indicated specially for the CAN data bus.

Convenience data bus

This fault is set if data transfer between two or more control units fails.

Possible fault causes are:

- Defective control units
- Open circuit in both data bus lines or
- in plug and socket connections

Printout on V.A.G 1551 printer
01328
Convenience data bus

SSP 186/40

Convenience data bus in emergency running mode

This fault is indicated if the CAN data bus has entered emergency mode.

Possible fault causes are:

- Open circuit in one data bus line or
- in a plug and socket connection

Printout on V.A.G 1551 printer
01329
Convenience data bus in emergency running mode

SSP 186/40

Function 08 - Read measured value block

Display group number 012 - **Central control unit** - displays four display fields relevant to the data bus.



Direct CAN data transfer currently cannot be checked using the available workshop facilities.

Display field 1: Check bus

This field indicates whether the data bus is OK or faulty (e.g. fault in single wire).

Display field 2: Equipment front

This field indicates which front control units are fitted and participate in data transfer.

Display field 3: Equipment rear

This field indicates which rear control units are fitted and participate in data transfer.

Display field 4: Accessories

This field indicates whether the seat and mirror adjustment memory system is fitted. Both systems (convenience system and memory system) interchange data.

Display group 012 - Central control unit					
Read measured value block 12				→	← Display on monitor
xxx	xxx	xxx	xxx		
1	2	3	4	← Display fields	Setpoint
Check Bus				Accessories	Memory / empty 1)
Equipment front				Equipment rear	RL RL and RR RR empty1)
					Driver Driver and FP FP empty1)
					Bus OK Bus NOK

SSP 186/41

CAN data bus in drive train

The data bus in the drive train

The CAN data bus links the following:

- The Motronic control unit
- The ABS/EDL control unit
- The automatic gearbox control unit

At the moment 10 data protocols are transferred.

Five from the Motronic control unit, three from the ABS/EDL control unit and two from the automatic gearbox control unit.

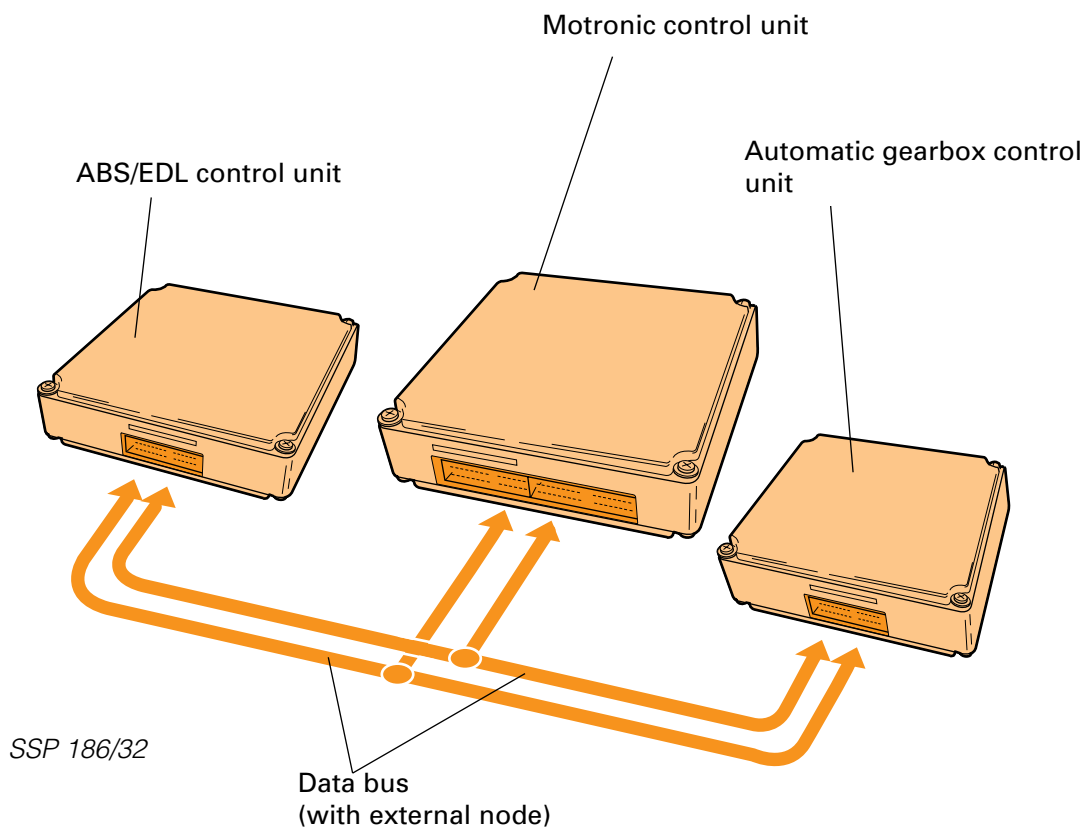

What special advantage does the CAN data bus have in the drive train?

- A high data transfer rate, with the result that the control units are very well-informed about the momentary state of the overall system and can execute functions optimally.

The features of the CAN data bus in the drive train

- The data bus comprises two lines along which information is transferred.
- In order to avoid electromagnetic interference and radiation emission, the two data bus lines are twisted together. Note the twist length.
- The data bus operates at a speed of 500 kbit/s (500,000 bits per second). This means that it lies in a speed range (high speed) from 125 - 1000 kbit/s. A data protocol transfer takes approx. 0.25 milliseconds.
- Each control unit (depending on type) tries to send its data at intervals of 7 - 20 milliseconds.
- Order of priority:
 1. ABS/EDL control unit →
 2. Motronic control unit →
 3. Automatic gearbox control unit



SSP 186/22



SSP 186/24

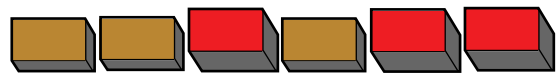

SSP 186/23

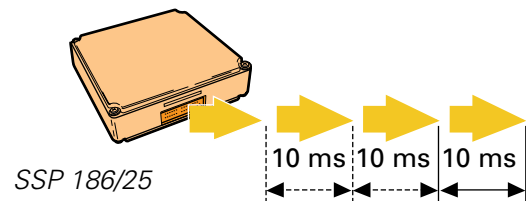

SSP 186/25

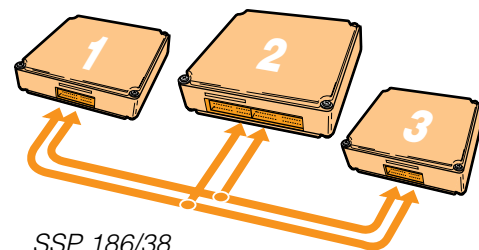

SSP 186/38

In the drive train, it must be possible to transfer the data very quickly so that it can be fully utilised.

For this purpose, a high-performance transceiver is required.

This transceiver facilitates data transfer between two ignition systems.

This means that the received data can be used for the next ignition impulse.

CAN data bus in drive train

The information in the drive train

What information is transferred?

The information in question is very important for the tasks of the individual control units. For safety reasons in the case of the ABS/EDL control unit, for reasons of controlling the ignition and quantity injected in the case of the engine control unit, and for reasons of driving convenience in the case of the automatic gearbox control unit.

The table shows you part of the data protocol and the individual data fields by way of an example.

Order of priority	Data protocol from	Examples of information
1	ABS/EDL control unit	- Request for engine braking control (EBC) - Request for Traction Control System (TCS)
2	Engine control unit, data protocol 1	- Engine speed - Throttle valve position - Kickdown
3	Engine control unit, data protocol 2	- Coolant temperature - Road speed
4	Automatic gearbox control unit	- Gearshift - Gearbox in emergency mode - Selector lever position

In the table below you can find examples of the format of an individual item of information. On account of the sheer number of items of information which have to be transferred, only one part is displayed.

The current position of the throttle valve is transferred with 8 bits, giving a possible of 256 bit permutations.

Thus, throttle valve positions from 0° to 102° can be transferred at 0.4° intervals.

Bit order	Throttle valve position
0000 0000	000.0° Throttle valve opening angle
0000 0001	000.4° Throttle valve opening angle
0000 0010	000.8° Throttle valve opening angle
...	...
0101 0100	033.6° Throttle valve opening angle
...	...
1111 1111	102.0° Throttle valve opening angle

Networking of the control units in the drive train

- J104 ABS/EDL control unit
- J217 Automatic gearbox control unit
- J220 Motronic control unit

In contrast to the convenience system, only a part of the overall system is displayed in the drive train. In this case, only the networking of the control units is shown.

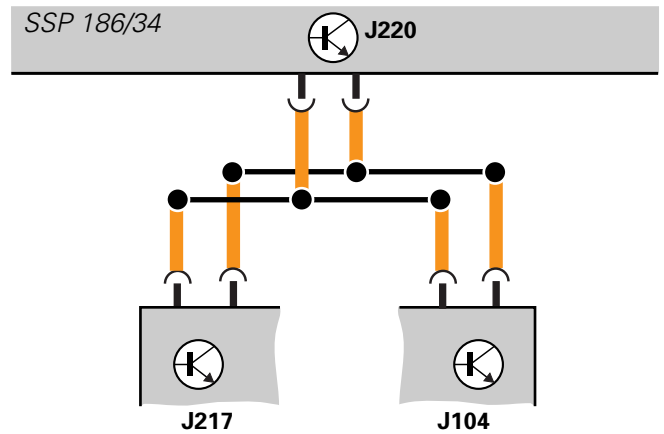

The node is usually located outside the control unit (in the wiring harness).

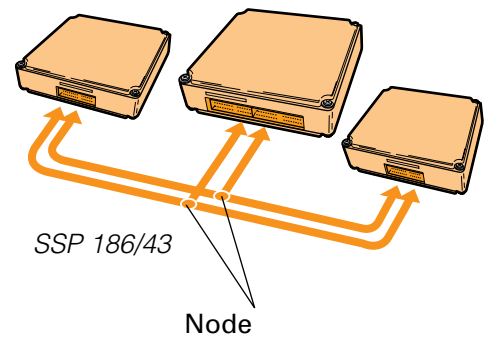

In exceptional cases, the node may be located in the engine control unit. In the illustration below, you can see the node at which the wires in the engine control unit converge.

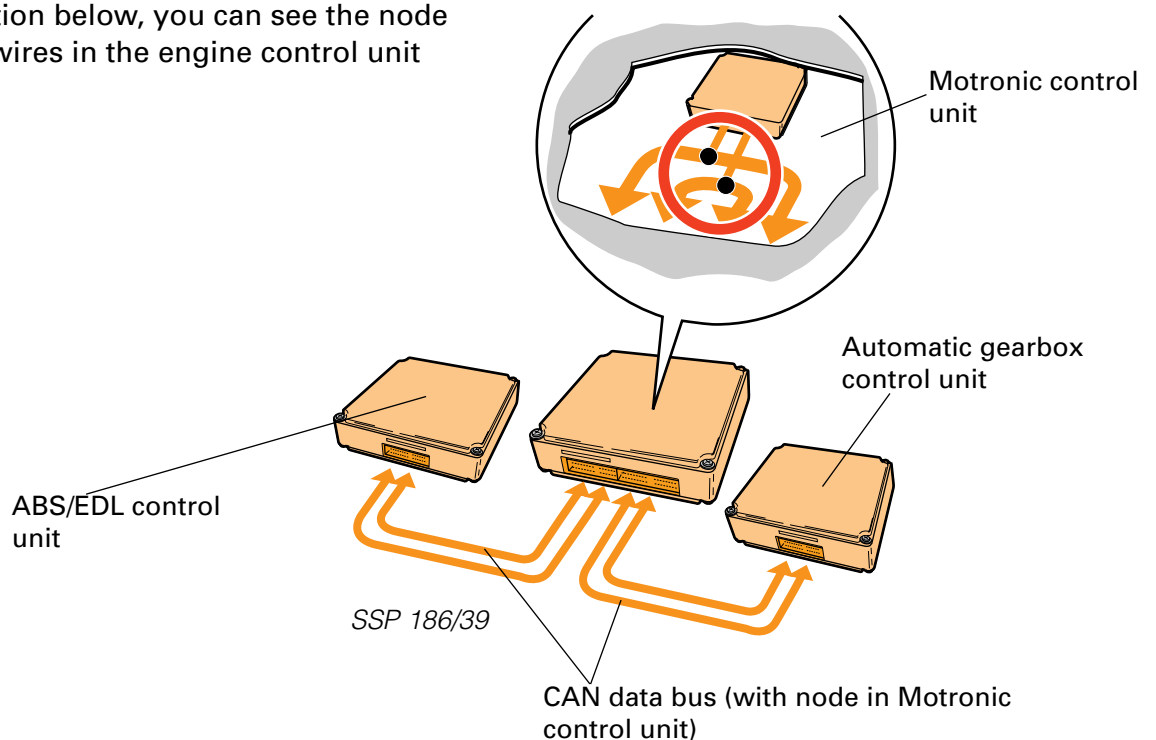

CAN data bus in drive train

Self-diagnosis of the CAN data bus in the drive train

Self-diagnosis can be performed with the V.A.G 1551/52 or VAS 5051 under these address words:

- 01 for engine electronics
- 02 for gearbox electronics
- 03 for ABS electronics



All control units which interchange information must be regarded as an integrated system during self-diagnosis and troubleshooting.

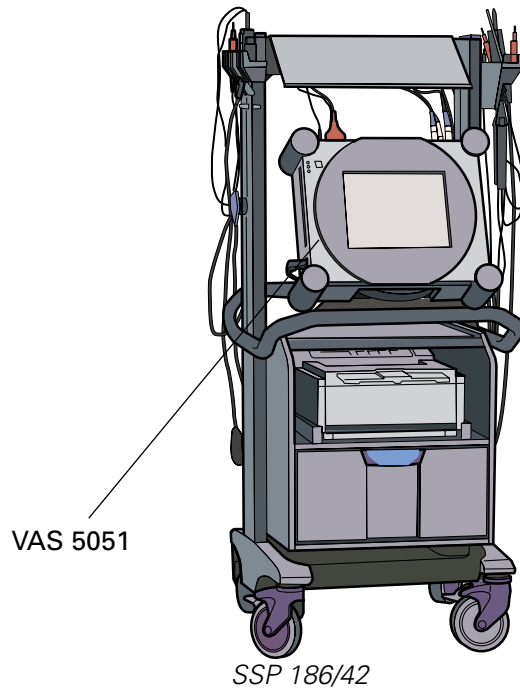

The following function is relevant to the CAN data bus:

Function 02 - Interrogate fault memory

A fault is stored in the control units if data transfer between the control units is disturbed:

- Open circuit in one or more data bus lines.
- Short circuit between data bus lines.
- Short circuit to earth or positive in a data bus line.
- One or more control units are defective.

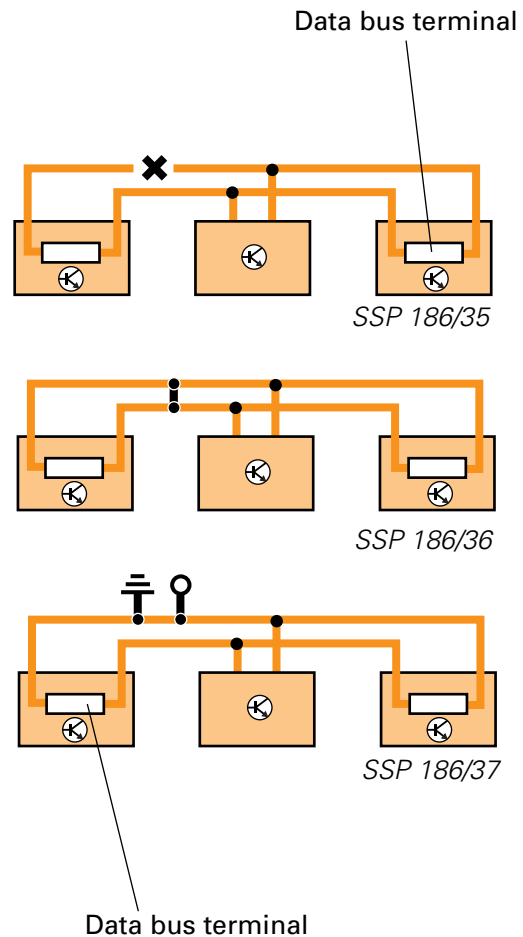

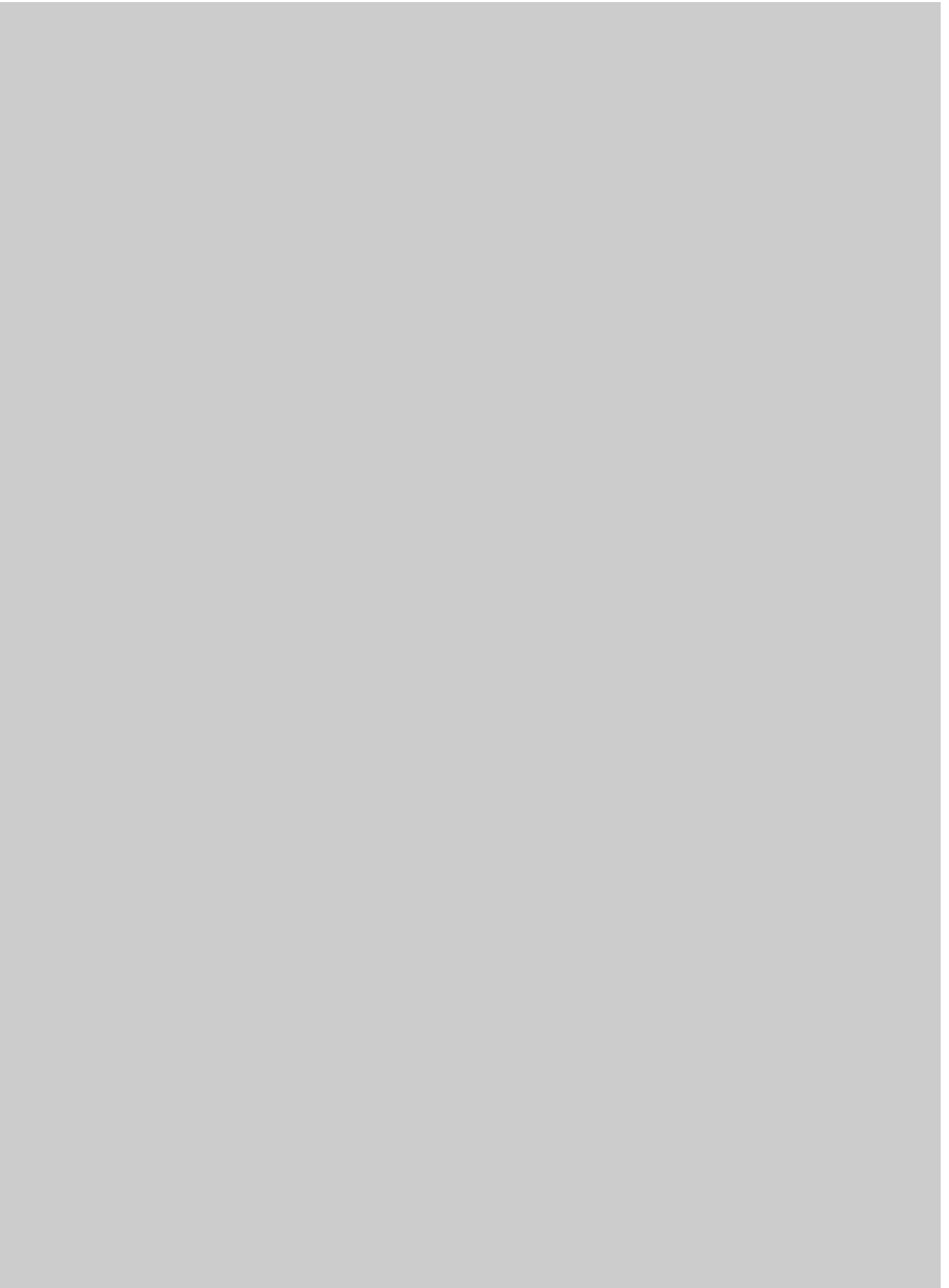

Test your knowledge

1. **In the CAN data bus,**

- A all items of information are sent over no more than two wires.
- B a separate wire is required for each item of information.

2. **The advantages of the CAN data bus are:**

- A Fewer sensors and signalling wires through multiple signal utilisation
- B More space is available through smaller control units and control units plugs
- C High-speed data transfer is possible
- D Low error rate through continuous verification of the data protocols

3. **With the CAN data bus, the following maximum number of items of information can be transferred with three bits:**

- A three items of information,
- B six items of information or
- C eight items of information.

4. **The CAN data bus**

- A has self-diagnostic capability.
- B does not have self-diagnostic capability.

5. **What points must be remembered for self-diagnosis and troubleshooting?**

- A None - since self-diagnosis and troubleshooting are not possible.
- B All the control units which interchange data must be regarded as an integrated system.
- C Each individual control unit must be regarded as being separate.

1. A: 2. A, B, C, D: 3. C: 4. A: 5. B