



Am27S31/27S31A

(512x8) Bipolar PROM

DISTINCTIVE CHARACTERISTICS

- High speed — 35 ns max commercial range access time
- Excellent performance over full military and commercial ranges
- Highly reliable, ultra-fast programming Platinum-Silicide fuses
- High programming yield
- Low current PNP inputs
- High current and three-state outputs
- Fast chip select

GENERAL DESCRIPTION

The Am27S31 (512 words by 8 bits) is a Schottky TTL Programmable Read-Only Memory (PROM).

This device is available in three-state output version compatible with low-power Schottky bus standards capable

of satisfying the requirements of a variety of microprogrammable controls, mapping functions, code conversion, or logic replacement. Easy word-depth expansion is facilitated by both active LOW (\overline{G}_1 and \overline{G}_2) and active HIGH (G_3 and G_4) output enables.

BLOCK DIAGRAM

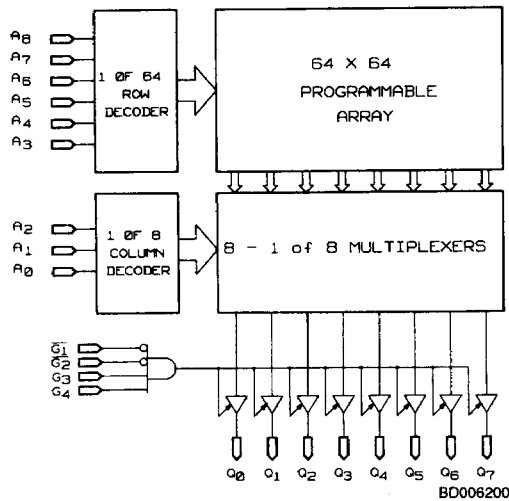

PRODUCT SELECTOR GUIDE

Part Number	Am27S31A		Am27S31	
Address Access Time	35 ns	45 ns	55 ns	70 ns
Operating Range	C	M	C	M

www.DataSheet.in

CONNECTION DIAGRAMS Top View

DIPs*

LCCs**

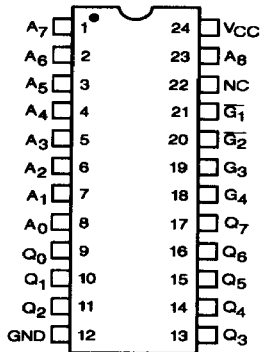

CD000701

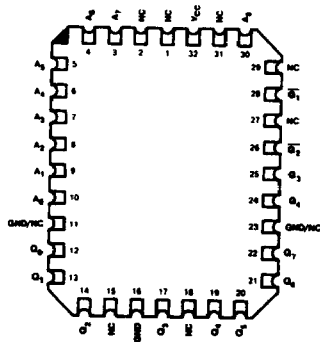

CD000711

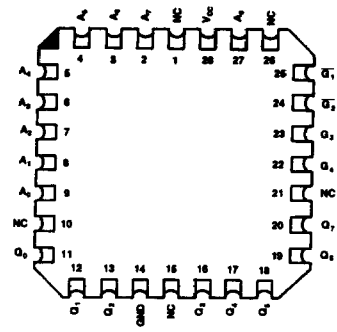

CD009461

*Also available in a 24-Pin Flatpack. Pinout identical to DIPs.

**Also available in a 28-Pin Square PLCC. Pinout identical to LCC.

Note: Pin 1 is marked for orientation.

LOGIC SYMBOL

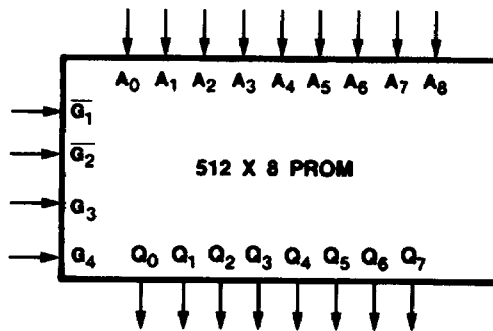

LS000151

V_{CC}/ = Power Supply
GND/ = Ground

ORDERING INFORMATION

Standard Products

AMD standard products are available in several packages and operating ranges. The order number (Valid Combination) is formed by a combination of:

- a. Device Number
- b. Speed Option (if applicable)
- c. Package Type
- d. Temperature Range
- e. Optional Processing
- f. Alternate Packaging Option

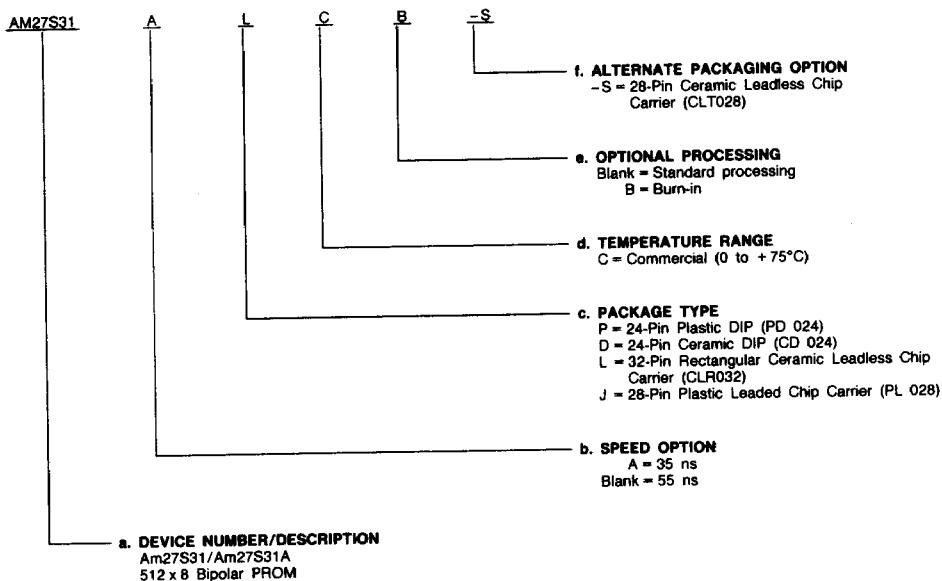

Valid Combinations	
AM27S31	PC, PCB, DC, DCB, LC, LC-S, LCB, LCB-S,
AM27S31A	JC, JCB

Valid Combinations

Valid Combinations list configurations planned to be supported in volume for this device. Consult the local AMD sales office to confirm availability of specific valid combinations, to check on newly released valid combinations, and to obtain additional data on AMD's standard military grade products.

MILITARY ORDERING INFORMATION

APL Products

AMD products for Aerospace and Defense applications are available in several packages and operating ranges. APL (Approved Products List) products are fully compliant with MIL-STD-883C requirements. The order number (Valid Combination) for APL products is formed by a combination of:

- a. Device Number
- b. Speed Option (if applicable)
- c. Device Class
- d. Package Type
- e. Lead Finish

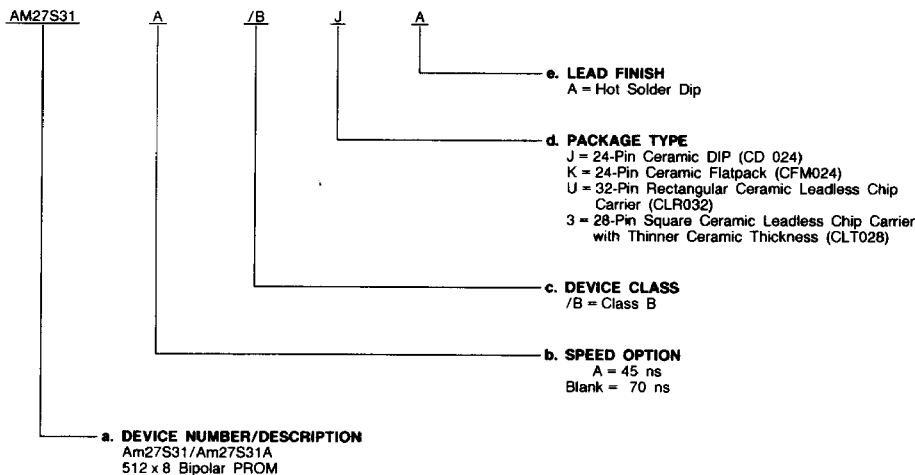

Valid Combinations

Valid Combinations list configurations planned to be supported in volume for this device. Consult the local AMD sales office to confirm availability of specific valid combinations or to check for newly released valid combinations.

Valid Combinations	
AM27S31	/BJA, /BKA,
AM27S31A	/BUA, /B3A

Group A Tests

Group A tests consist of Subgroups
1, 2, 3, 7, 8, 9, 10, 11.

MILITARY BURN-IN

Military burn-in is in accordance with the current revision of MIL-STD-883, Test Method 1015, Conditions A through E. Test conditions are selected at AMD's option.

PIN DESCRIPTION

A₀ - A₈ Address Inputs

The 9-bit field presented at the address inputs selects one of 512 memory locations to be read from.

Q₀ - Q₇ Data Output Port

The Outputs whose state represents the data read from the selected memory locations.

$\overline{G}_1, \overline{G}_2, G_3, G_4$ Output Enable

Provides direct control of the Q-output buffers. Outputs disabled forces all three-state outputs to a floating or high-impedance state.

$$\text{Enable} = \overline{G}_1 \cdot \overline{G}_2 \cdot G_3 \cdot G_4$$

$$\begin{aligned} \text{Disable} &= \overline{G}_1 \cdot \overline{G}_2 \cdot G_3 \cdot G_4 \\ &= G_1 + G_2 + \overline{G}_3 + \overline{G}_4 \end{aligned}$$

VCC Device Power Supply Pin

The most positive of the logic power supply pins.

GND Device Power Supply Pin

The most negative of the logic power supply pins.

ABSOLUTE MAXIMUM RATINGS

Storage Temperature	-65 to +150°C
Ambient Temperature with Power Applied	-55 to +125°C
Supply Voltage	-0.5 V to +7.0 V
DC Voltage Applied to Outputs (Except During Programming)	-0.5 V to +V _{CC} Max.
DC Voltage Applied to Outputs During Programming	21 V
Output Current into Outputs During Programming (Max Duration of 1 sec)	250 mA
DC Input Voltage	-0.5 V to +5.5 V
DC Input Current	-30 mA to +5 mA

Stresses above those listed under ABSOLUTE MAXIMUM RATINGS may cause permanent device failure. Functionality at or above these limits is not implied. Exposure to absolute maximum ratings for extended periods may affect device reliability.

OPERATING RANGES

Commercial (C) Devices	
Ambient Temperature (T _A)	0 to +75°C
Supply Voltage (V _{CC})	+4.75 V to +5.25 V
Military (M) Devices*	
Case Temperature (T _C)	-55 to +125°C
Supply Voltage (V _{CC})	+4.5 V to +5.5 V

Operating ranges define those limits between which the functionality of the device is guaranteed.

*Military Product 100% tested at T_C = +25°C, +125°C, and -55°C.

DC CHARACTERISTICS over operating ranges unless otherwise specified (for APL Products, Group A, Subgroups 1, 2, 3 are tested unless otherwise noted)

Parameter Symbol	Parameter Description	Test Conditions	Min.	Typ.	Max.	Unit
V _{OH} (Note 1)	Output HIGH Voltage	V _{CC} = Min., I _{OH} = -2.0 mA V _{IN} = V _{IH} or V _{IL}	2.4			V
V _{OL}	Output LOW Voltage	V _{CC} = Min., I _{OL} = 16 mA V _{IN} = V _{IH} or V _{IL}			0.50	V
V _{IH}	Input HIGH Level	Guaranteed input logical HIGH voltage for all inputs (Note 2)	2.0			V
V _{IL}	Input LOW Level	Guaranteed input logical LOW voltage for all inputs (Note 2)			0.8	V
I _{IL}	Input LOW Current	V _{CC} = Max., V _{IN} = 0.45 V			-0.250	mA
I _{IH}	Input HIGH Current	V _{CC} = Max., V _{IN} = 2.7 V			25	μA
I _{SC} (Note 1)	Output Short-Circuit Current	V _{CC} = Max., V _{OUT} = 0.0 V (Note 3)	-20		-90	mA
I _{CC}	Power Supply Current	All inputs = GND V _{CC} = Max.			175	mA
V _I	Input Clamp Voltage	V _{CC} = Min., I _{IN} = -18 mA			-1.2	V
I _{CEX}	Output Leakage Current	V _{CC} = Max. V _{G1} = 2.4 V			40	μA
		(Note 1)			40	
					-40	
C _{IN}	Input Capacitance	V _{IN} = 2.0 V @ f = 1 MHz (Note 4) V _{CC} = 5 V, T _A = 25°C		4		pF
C _{OUT}	Output Capacitance	V _{OUT} = 2.0 V @ f = 1 MHz (Note 4) V _{CC} = 5 V, T _A = 25°C		8		

Notes: 1. This applies to three-state devices only.

- V_{IL} and V_{IH} are input conditions of output tests and are not themselves directly tested. V_{IL} and V_{IH} are absolute voltages with respect to device ground and include all overshoots due to system and/or tester noise. Do not attempt to test these values without suitable equipment.
- Not more than one output should be shorted at a time. Duration of the short circuit should not be more than one second.
- These parameters are not 100% tested, but are evaluated at initial characterization and at any time the design is modified where capacitance may be affected.

SWITCHING CHARACTERISTICS over operating ranges unless otherwise specified (for APL Products, Group A, Subgroups 9, 10, 11 are tested unless otherwise noted*)

No.	Parameter Symbol	Parameter Description	Am27S31A				Am27S31				Unit
			COM'L		MIL		COM'L		MIL		
			Min.	Max.	Min.	Max.	Min.	Max.	Min.	Max.	
1	TAVQV	Address Valid to Output Valid Access Time		35		45		55		70	ns
2	TGVQZ	Delay from Output Enable Valid to Output Hi-Z		20		25		25		30	ns
3	TGVQV	Delay from Output Enable Valid to Output Valid		20		25		25		30	ns

See also Switching Test Circuits.

- Notes: 1. Tests are performed with input transition time of 5 ns or less, timing reference levels of 1.5 V, and input pulse levels of 0 to 3.0 V using test load in A under Switching Test Circuits.
 2. TGVQZ is measured at steady state HIGH output voltage -0.5 V and steady state LOW output voltage +0.5 V output levels using the test load in B under Switching Test Circuits.

*Subgroups 7 and 8 apply to functional tests.

SWITCHING TEST CIRCUITS

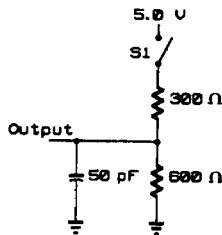

TC003442

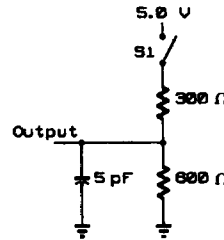

TC003452





A. Output Load for all A - C tests except TGVQZ

B. Output Load for TGVQZ

- Notes: 1. All device test loads should be located within 2" of device output pin.
 2. S₁ is open for Output Data HIGH to Hi-Z and Hi-Z to Output Data HIGH tests. S₁ is closed for all other AC tests.
 3. Load capacitance includes all stray and fixture capacitance.

SWITCHING WAVEFORMS

KEY TO SWITCHING WAVEFORMS

WAVEFORM	INPUTS	OUTPUTS
	MUST BE STEADY	WILL BE STEADY
	MAY CHANGE FROM H TO L	WILL BE CHANGING FROM H TO L
	MAY CHANGE FROM L TO H	WILL BE CHANGING FROM L TO H
	DON'T CARE: ANY CHANGE PERMITTED	CHANGING, STATE UNKNOWN
	DOES NOT APPLY	CENTER LINE IS HIGH IMPEDANCE "OFF" STATE

KS000010

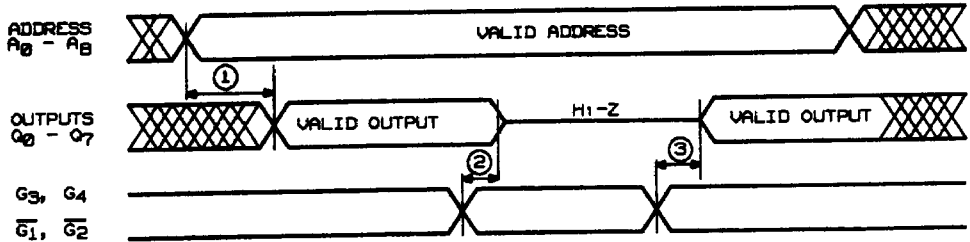

WF021260